

6

5

4

3

2

1

REVISION

ZONE	REV	DESCRIPTION	DATE	CHANGED BY	APPROVED
	A	INITIAL RELEASE	02/05/2024	DMAY	DGUTTADAURO

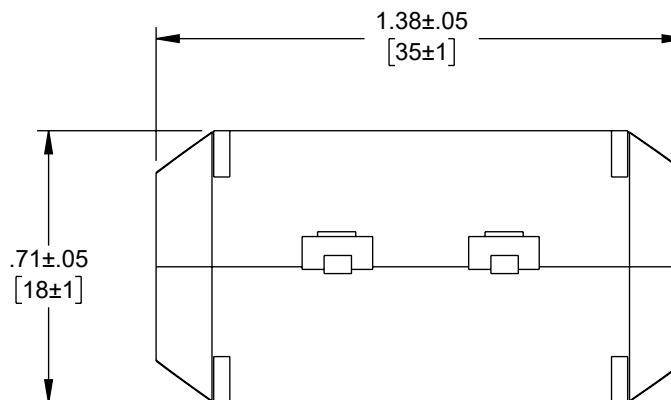
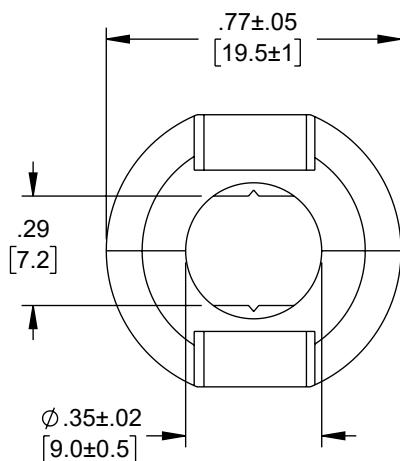

THE INFORMATION CONTAINED IN THIS DRAWING IS THE SOLE PROPERTY OF INFINITE ELECTRONICS, INC. ANY REPRODUCTION IN PART OR WHOLE WITHOUT THE WRITTEN PERMISSION OF INFINITE ELECTRONICS, INC. IS PROHIBITED. THESE COMMODITIES, TECHNOLOGY OR SOFTWARE WERE EXPORTED FROM THE UNITED STATES IN ACCORDANCE WITH THE EXPORT ADMINISTRATION REGULATIONS. DIVERSION CONTRARY TO U.S. LAW PROHIBITED.

UNLESS OTHERWISE SPECIFIED
LEADING DIMENSIONS ARE INCHES
DIMENSIONS IN [] ARE MILLIMETERS

TOLERANCES:
 .X = ±.2 [5] FRACTIONS
 .XX = ±.02 [0.5] ± 1/32
 .XXX = ±.005 [0.13] ANGLES ± 1°

CABLE LENGTH TOLERANCES:
 ≤12 [305] = +1 [25] / -0
 >12 [305] ≤ 60 [1524] = +2 [51] / -0
 >60 [1524] ≤ 120 [3048] = +4 [102] / -0
 >120 [3048] ≤ 300 [7620] = +6 [152] / -0
 >300 [7620] = +5% / -0

ALL DIMENSIONS ARE FOR REFERENCE ONLY
AND SUBJECT TO CHANGE WITHOUT NOTICE.
UN-DIMENSIONED/NON-CRITICAL FEATURES
MAY VARY IN SIZE AND LOCATION
COLORS MAY VARY

Show Me™
CABLES

an INFINIT® brand

Website: www.ShowMeCables.com
Phone: 1.888.519.9505



INTERPRET ALL DIMENSIONS AND
TOLERANCES PER ASME Y14.5

SCALE	SHEET
NONE	1 OF 1

DESCRIPTION

SNAP TOGETHER SPLIT FERRITE CORES 9mm

SIZE	CAGE CODE	DRAWN BY	ITEM NO.	REV
A	3SVT8	DMAY	SFERR-9MM	A

6

5

4

3

2

1